

# C A T Á L O G O

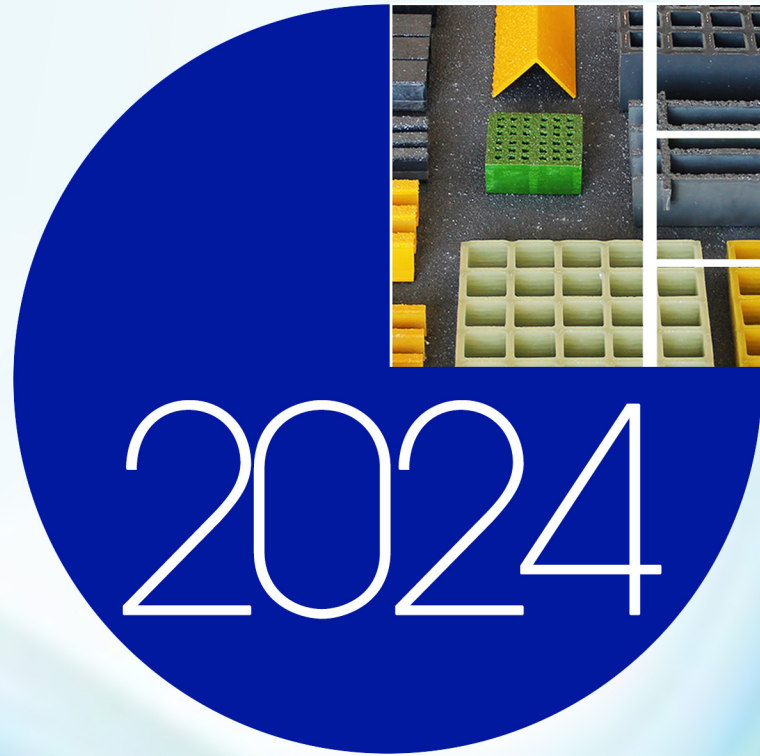
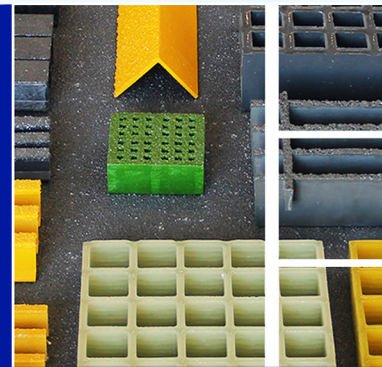
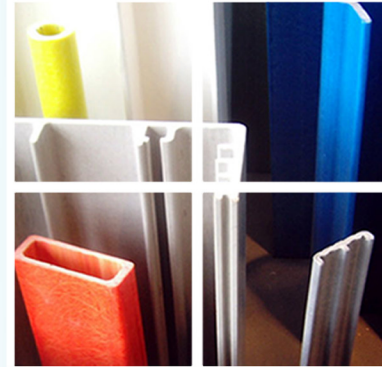
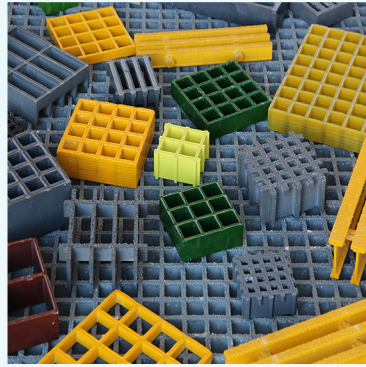
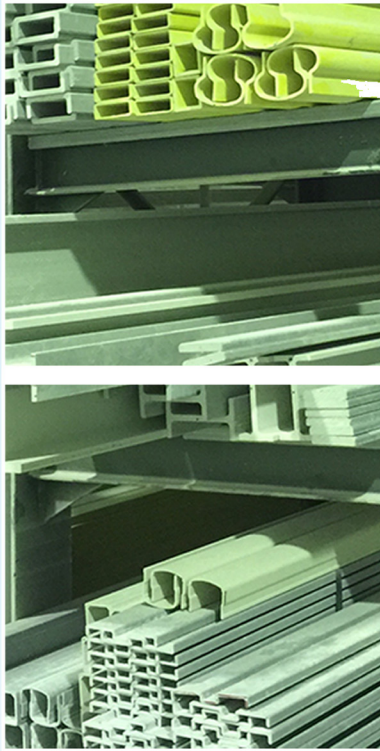

# Tubo Quadrado

**ibérica** pultrusionados

# Desenho Técnico

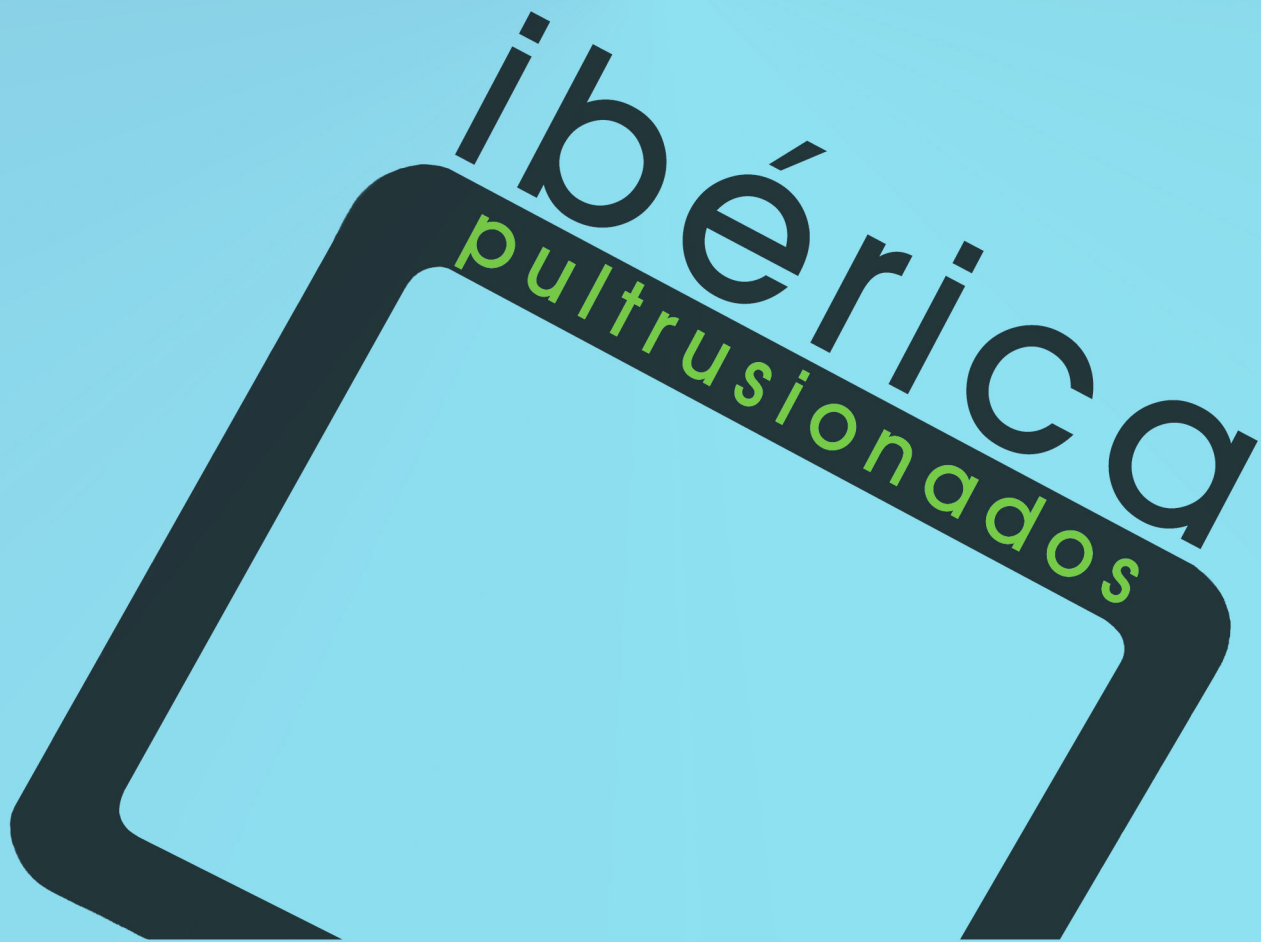

Iberica Pultrusionados @ 2016 - Direitos Reservados

Travessa do Bairro nº 50 - Z.I. Aveleda - Armazém B | 4485-010 AVELEDA VDC - Portugal | Tel.: +351 22 9960117 | info@iberica-pultrusionados.com | www.iberica-pultrusionados.com

## Tubos quadrados | Tabelas

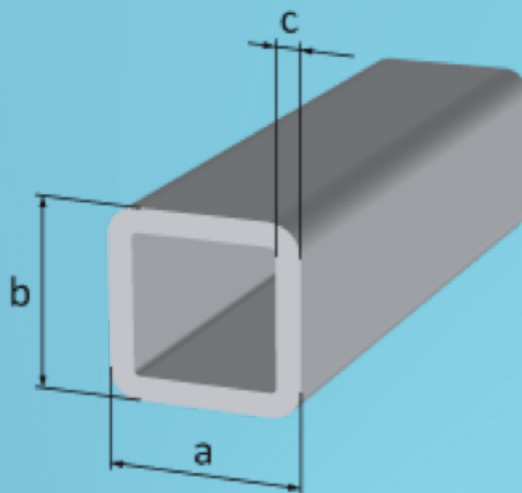

### Tubo 50x50x5 | Características

Referência	IBP.9405001	a(mm)	b(mm)	c(mm)			
		50	50	5			

### Tubo 50x50x3,5 | Características

Referência	IBP.9405001_1	a(mm)	b(mm)	c(mm)			
		50	50	3,5			

### Tubo 30x20x3 | Características

Referência	IBP.9406001	a(mm)	b(mm)	c(mm)			
		30	20	3			

### Tubo 70x24x3 | Características

Referência	IBP.9406003	a(mm)	b(mm)	c(mm)			
		70	24	3			

### Tubo 103,5x83,5x10 | Características

Referência	IBP.9406005	a(mm)	b(mm)	c(mm)			
		103,5	83,5	10			

### Tubo 150x25x3 | Características

Referência	IBP.9413002	a(mm)	b(mm)	c(mm)			
		150	25	3			

# ibérica pultrusionados

